

Verbindungstechnik – LWL

[Network Connectivity - FO]

LWL - vorkonfektionierte Kassette LC – OM3 [FO pre-terminated cassette LC – OM3]

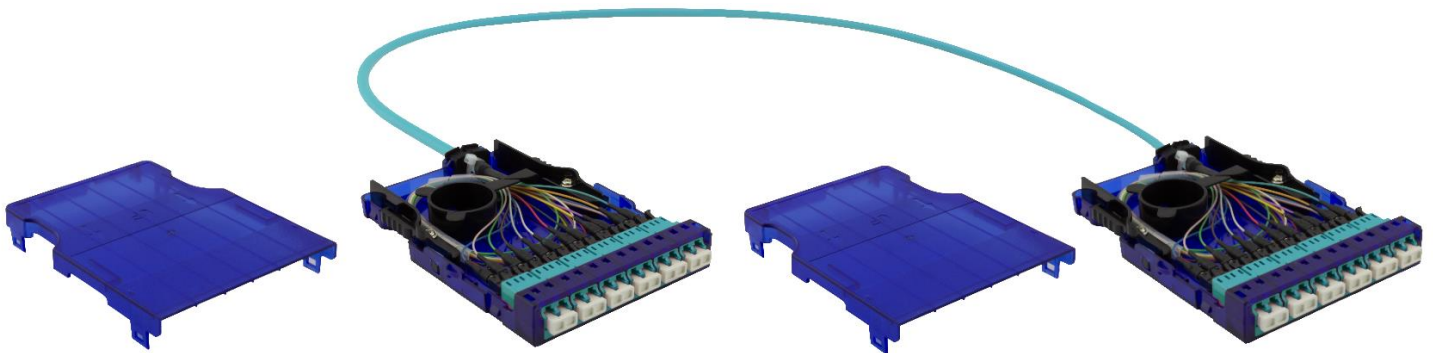

Die vorkonfektionierten, modularen LWL-Kassetten von TKM sind direkt geeignet für die Verwendung in Glasfasernetzen. Speziell in Rechenzentrumsanwendungen ist die modulare Nutzung von gemischten LC, SC und RJ45 Ports in einem Chassis von großer Bedeutung. Die modularen Kassetten haben folgende Haupteigenschaften:

- Plug & Play – werkzeuglose Installation im 19" Chassis
- Kapazität: bis zu 12 Fasern pro Kassette
- Mischbar mit modularen Kupferkassetten im selben Chassis
- Optional: Kassetten auch als Spleißversion und MPO/MTP® Version verfügbar
- CPR-Klasse: D_{ca}

[The pre-terminated, modular FO cassettes of TKM are direct applicable to use in FO networks. Especially in data center applications the modular usage of LC, SC and RJ45 ports in one chassis is highly relevant. The modular cassettes have the following main characteristics:

- *plug & play – toolless installation in 19inch chassis*
- *capacity: up to 12 fibres per cassette*
- *mixable with copper cassette in the same chassis*
- *optional: cassette also available as splice and MPO/MTP® version*
- *CPR class: D_{ca}*

Eigenschaften Kassette [characteristics cassette]

Spezifikation Kassette [specification cassette]				
Gemäß Standard [acc. to specification]	IEC 60793-2-10			
Material Gehäuse [material housing]	PC – Polycarbonate			
Material Verriegelung [material release lug]	PP - Polypropylen			
Optische Eigenschaften Kupplung [optical characteristics adapter]				
Kupplungstyp [type of adapter]	LCdx			
Material Kupplung [material adapter]	PEI - Polyetherimid			
Material Ferrule [material ferrule]	Keramik [ceramic]			
Farbe Kupplung [colour adapter]	Aqua – ähnlich RAL 6027 [aqua – similar RAL 6027]			
Steckzyklen [mating cycles]	> 750			
Optische Eigenschaften Stecker [optical characteristics connector]				
Qualitätsstufe [quality type]	HS – High Standard	GB – Grade B	GC – Grade C	
Hersteller / Marke des Steckers [manufacturer / brand of connector]	Huber & Suhner [Huber & Suhner]	n.a.	n.a.	
Farbe Stecker [colour connector]	Schwarz [black]	n.a.	n.a.	
Farbe Knickschutz [colour boot]	Aqua [aqua]	n.a.	n.a.	
IL@97% [db]: // RL [db]: IL (typical) [db]: // RL (typical) [db]: IEC 61300-3-34 / IEC 61300-3-6	≤ 0,25 ≥ 35 ≤ 0,12 ≥ 45	n.a.	n.a.	
	GRADE B/3			

Zeichnung
[drawing]

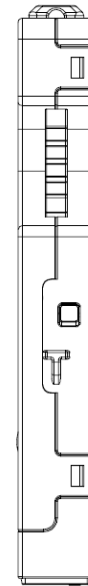
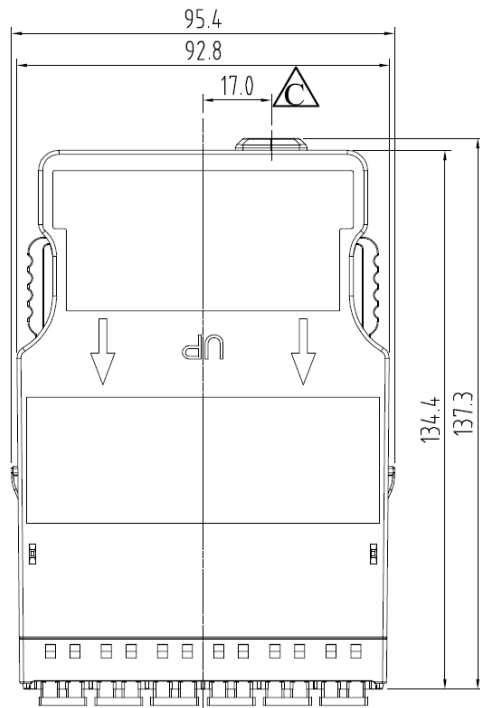

1 Kassettenunterteil
[bottom part of cassette]

2 LWL Kupplung
[FO adapter]

3 Entriegelungslasche linksseitig
[release latch left sided]

4 Entriegelungslasche rechtsseitig
[release latch right sided]

5 Gummielement für Kabeleinführung mit Zugentlastung
[rubber element with cable entry and strain relief]

6 Verschraubung
[screw connection]

7 Faserspule
[fibre spool]

8 Kassettenoberteil
[top part of cassette]

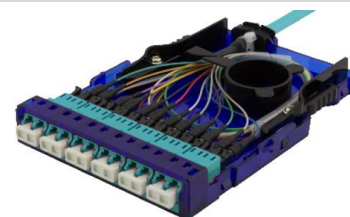
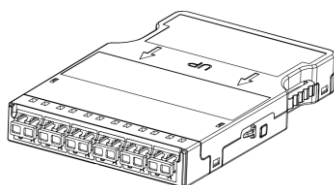
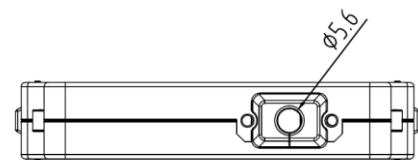
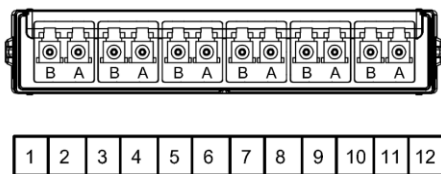
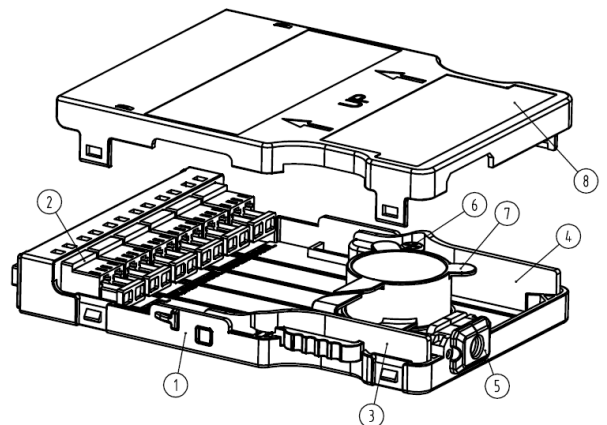

Eigenschaften Minibreakout Indoorkabel I-V(ZN)H [characteristics minibreakout indoor cable I-V(ZN)H]

Kabelaufbau [cable construction]

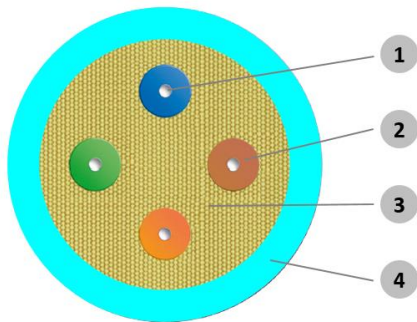

*exemplarisch mit 4 Fasern
[exemplarily with 4 fibres]

1	Glasfasern [fibres]
2	Semilose Vollader [semi loose tube]
3	Glasarmierung [glass armour]
4	Außenmantel FRNC/LSZH [outer jacket FRNC/LSZH]

Anwendung [application]

Vorkonfektioniertes modulare Kassette zur Anwendung in bspw. einem Rechenzentrumsnetzwerk, einer Etagen- oder Gebäudeverkabelung
[pre-terminated modular cassette for the application in e.g. data center networks, floor or enterprise network]

Farbe Außenmantel [colour outer jacket]

Aqua
[aqua]

Typ Ader: [type of fibre]

Semilose Vollader
[semi-tight buffered fibre]

Außendurchmesser [mm] [outer diameter [mm]]

0,9

Farbcode der Adern [colour code of fibres]

blau, orange, grün, braun, grau, weiß, rot, schwarz, gelb, violett, rosa, türkis
[blue, orange, green, brown, grey, white, red, black, yellow, violet, pink, turquoise]

Min. Biegeradius nach IEC 60794-1-2 E11A in XX x Außendurchmesser [min bending radius acc. to IEC 60794-1-2 E11A in XX x outer diameter]

Fest verlegt (statisch)

10

Während Montage (dynamisch)

15

Spezifikation: Faser [specification: fibre]

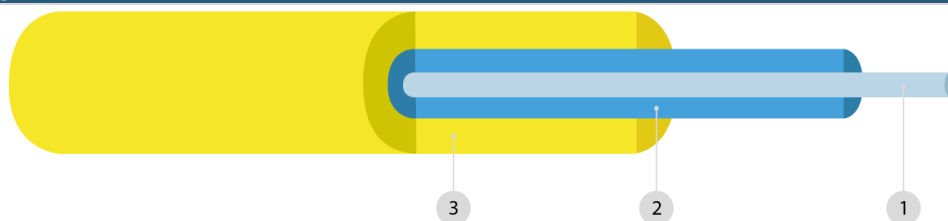

*exemplarische Abbildung, Produkt kann farblich abweichen
[exemplary picture, product may vary in colour]

1	Kern [core]	2	Ummantelung [cladding]	3	Beschichtung [coating]
---	----------------	---	---------------------------	---	---------------------------

Fasertyp [type of fibre]

Multimode Faser, biegeunempfindlich, G50/125, OM3
[multimode fibre, bend optimised, G50/125, OM3]

Faserspezifikation [fibre specification]

ITU-T G.651.1, IEC 60793-2-10 type A1a.2b

Übertragungseigenschaften [transmission characteristics]	Messwerte Produkt [measurement value of product]			Normwerte [measurement value of standard]		
Wellenlänge [nm] [wave length [nm]]	850	953	1300	850	953	1300
Dämpfung maximal (unkabelt) [db/km] [attenuation maximum (uncabled) [db/km]]	2,30	n.a.	0,60	n.a. [n.a.]	n.a. [n.a.]	n.a. [n.a.]
Dämpfung maximal verkabelt [db/km] [attenuation maximum (cabled) [db/km]]	2,5	n.a.	0,7	3,5	n.a. [n.a.]	1,5
OFL-Bandbreite [MHz x km] [OFL bandwidth [MHz x km]] TIA/EIA 455-204 // IEC 60793-1-41	1500	n.a.	500	1500	n.a. [n.a.]	500
High-Performance EMB-Bandbreite [MHz x km] [high-Performance EMB bandwidth [MHz x km]] TIA/EIA 455-220A // IEC 60793-1-49	2000	n.a.	n.a. [n.a.]	2000	n.a. [n.a.]	n.a. [n.a.]
Brechzahlindex [refractive index]	1,483	n.a. [n.a.]	1,478	n.a. [n.a.]		
Biegeeigenschaften [macrobending characteristics]	Anzahl Windungen [numbre of windings]			Max. induzierte Biegedämpfung [dB] [max. induced attenuation [dB]]		
				@850nm	@1300nm	
Biegeradius R=37,5mm [bending radius R=37.5mm]	100			0,1	0,15	
Biegeradius R=15mm [bending radius R=15mm]	2			0,1	0,3	
Biegeradius R=7,5mm [bending radius R=7.5mm]	2			0,2	0,5	
Mechanische Eigenschaften [mechanical characteristics]						
Numerische Apertur [numerical aperture]	0,200 ± 0,015					
Kerndurchmesser [µm] [core diameter [µm]]	50,0 ± 2,5					
Maximale Unrundheit des Kerns [%] [maximum core non-circularity [%]]	< 5					
Glasmanteldurchmesser [µm] [cladding diameter [µm]]	125,0 ± 1,0					
Maximale Unrundheit des Glasmantels [%] [maximum cladding non-circularity [%]]	< 1					
Maximale Kern-/Mantel-Konzentrität [µm] [maximum cladding/core concentricity error [µm]]	< 1.5					
Max. Coating-Konzentritätsabweichung [µm] [max. coating concentricity error [µm]]	< 10					
Coating [µm] [coating [µm]]	245 ±10					
Eigenschaften - Linklängen [characteristics - link length]						
IEEE 802.3 Serie [IEEE 802.3 series]	Wellenlänge [nm] [wave length [nm]]	Linklänge Produkt [m] [link length product [m]]		Linklänge nach Norm [m] [link length acc. to standard [m]]		
1000 Base-SX	850	1000		800		
1000 Base-LX	1300	550		n.a.		
10 GBase-SX	850	300		300		
10 GBase-LX	1310	300		n.a.		
Thermische Eigenschaften - Kabel [thermal characteristics - cable]						
Betriebstemperatur [operation temperature]	-5°C // +70°C					
Lagertemperatur [storage temperature]	-25°C // +70°C					
Mechanische Eigenschaften - Kabel [mechanical characteristics - cable]						
Zugfestigkeit [N] [tensile performance [N]]	800					
Querdruckstabilität [N/100mm] [crush resistance [N/100mm]]	500					

Schlag [<i>impact</i>]	nach [<i>acc. to</i>]	n.a.
Wiederholte Biegung [<i>repeated bending</i>]	nach [<i>acc. to</i>]	n.a.
Torsion [<i>torsion</i>]	nach [<i>acc. to</i>]	n.a.
Kabelbiegung [<i>bend</i>]	nach [<i>acc. to</i>]	n.a.
Längswasserdichtigkeit [<i>water penetration</i>]	nach [<i>acc. to</i>]	n.a.

Normen [*standards*]

UV Beständigkeit [<i>UV resistance</i>]	n.a.		
Brandklasse [<i>fire classification</i>]	nach [<i>acc. to</i>]	Dca-s2-d2-a2	EN 50575 / EN 50399
Halogenfreiheit / Korrosivität [<i>zero halogen, no corrosive gases</i>]	nach [<i>acc. to</i>]	IEC 60754-1	
Flammwidrigkeit [<i>flame propagation</i>]	nach [<i>acc. to</i>]	IEC 60332-1-2, IEC 60332-3-22 Cat. A	
Brandfortleitung [<i>flame spread</i>]	nach [<i>acc. to</i>]	IEC 60332	
Bedruckung [<i>printing</i>]	nach [<i>acc. to</i>]	LEONI - "Product type" - IV(ZN)H - Number of fibers - CPR Class - DoP Number - Prod. Batch"	

Kabelversionen [*cable versions*]

Eigenschaft [<i>characteristics</i>]	Anzahl Fasern [<i>QTY fibres</i>]	Farbe [<i>colour</i>]	Fasertyp [<i>fibres type</i>]	Mantel [<i>jacket</i>] Ø [mm]	Gewicht [<i>weight</i>] [kg/km]	Biegeradius [<i>bending radius</i>] [mm]	Zugkraft [<i>tensile load</i>] [N]	Querdruck, dauernd [<i>crush resistance, continuous</i>] [N]	Querdruck, kurzzeitig [<i>crush resistance, short term</i>] [N]	Brandlast [<i>fire load</i>] [kWh/m]
Werte [<i>values</i>]	12	aqua [<i>aqua</i>]	G50/125 OM3	7.0	38	70	800	500	n.a.	0.150

Lieferform [*delivery type*]

Lieferform bis 50m // ab 50m [<i>type of delivery up to 50m // from 50m on</i>]	als Kabelring // auf Trommel [<i>as cable ring // on drum</i>]
Gewicht (exemplarisch 1m Trunk) [kg] [<i>weight (exemplary 1m trunk) [kg]</i>]	0,29
Gewicht Mehrmeter [kg] [<i>weight additional meter [kg]</i>]	0,038



1	Gesamtlänge in Decimeter [<i>total length in decimeter</i>]	2	Kassettengehäuse [<i>cassette housing</i>]
3	Entriegelungslasche [<i>release lug</i>]	4	Multifaserkabel [<i>multifibre cable</i>]

Polarität <i>[polarity]</i>	1:1 Verbindung <i>[1:1 connection]</i>	1B - 1B
		1A - 1A
		2B - 2B
		2A - 2A
		3B - 3B
		3A - 3A
		4B - 4B
		4A - 4A
		5B - 5B
		5A - 5A
		6B - 6B
		6A - 6A
Polarität <i>[polarity]</i>	X - gekreuzt <i>[X - crossed]</i>	1B - 1A
		1A - 1B
		2B - 2A
		2A - 2B
		3B - 3A
		3A - 3B
		4B - 4A
		4A - 4B
		5B - 5A
		5A - 5B
		6B - 6A
		6A - 6B

Bestellangaben *[ordering information]*

Artikelnummer <i>[part no.]</i>	Beschreibung <i>[description]</i>
4677404-A-5-XXX	CAS-PRE-DSI - RZ-Trunkkabel (Dca) - 2x Modulkassette 6xLCdx OM3 - aqua - Polarität: 1:1 - Kabeltyp: LE - Länge: XX,Xm <i>[CAS-PRE-DSI - DC-Trunk Cable (Dca) - 2x modular cassette 6xLCdx OM3 - aqua - polarity: 1:1 - cable type: LE - length: XX.Xm]</i>
4677444-A-5-XXX	CAS-PRE-DSX - RZ-Trunkkabel (Dca) - 2x Modulkassette 6xLCdx OM3 - aqua - Polarität: gekreuzt - Kabeltyp: LE - Länge: XX,Xm <i>[CAS-PRE-DSX - DC-Trunk Cable (Dca) - 2x modular cassette 6xLCdx OM3 - aqua - polarity: crossed - cable type: LE - length: XX.Xm]</i>
	XXX - Längenangabe in Dezimeter // 010 ± 1,00 Meter <i>[XXX - length information in decimeter // 010 ± 1,00 meter]</i>

Bestellangaben - Zubehör *[ordering information - accessories]*

Artikelnummer <i>[part no.]</i>	Beschreibung <i>[description]</i>
4677270	Verteilerfeldrahmen (leer) zur Aufnahme von 8x Modulkassetten inkl. Kabelmanagementbügel <i>[Patch panel chassis (empty) for mounting of 8x modular cassettes incl. cable management]</i>
4677279	Luftabschlussblende zur Vermeidung unkontrollierter Luftzirkulation für modulares Verteilerfeld <i>[Blanking plate for stopping uncontrolled air circulation for modular patch panel]</i>