

Verbindungstechnik – LWL

[Network Connectivity - FO]

LWL – MPO/MTP®-Kassette LC – OM3

[FO MPO/MTP® cassette LC – OM3]

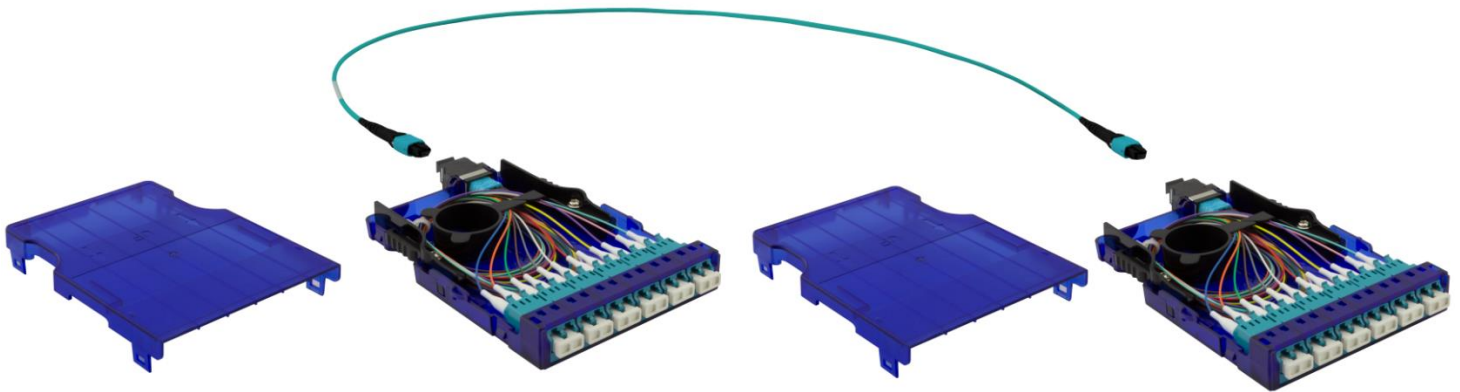



Die modularen LWL-Kassetten als MPO/MTP® Version von TKM sind direkt geeignet für die Verwendung in Glasfasernetzen. Speziell in Rechenzentrumsanwendungen ist die modulare Nutzung von gemischten LC, SC und RJ45 Ports in einem Chassis von großer Bedeutung. Die modularen Kassetten haben folgende Haupteigenschaften:

- Plug & Play – werkzeuglose Installation im 19“ Chassis
- Kapazität: bis zu 12 Fasern pro Kassette
- Mischbar mit modularen Kupferkassetten im selben Chassis
- Kassettenversion: MPO/MTP® Breakoutkabel innenliegend in Kassette

[The modular FO MPO/MTP® cassettes of TKM are direct applicable to use in FO networks. Especially in data center applications the modular usage of LC, SC and RJ45 ports in one chassis is highly relevant. The modular cassettes have the following main characteristics:

- *plug & play – toolless installation in 19inch chassis*
- *capacity: up to 12 fibres per cassette*
- *mixable with copper cassette in the same chassis*
- *cassette version: MPO/ MTP® breakout cable inside cassette]*

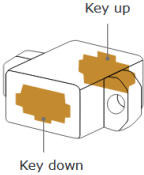
Eigenschaften Kassette [characteristics cassette]

Spezifikation Kassette [specification cassette]			
Gemäß Standard [acc. to specification]	IEC 60793-2-10		
Material Gehäuse [material housing]	PC – Polycarbonate		
Material Verriegelung [material release lug]	PP - Polypropylen		
Frontseite: Eigenschaften Kupplung [front side: characteristics adapter]			
Kupplungstyp Frontseite [type of adapter front side]	LCdx		
Material Kupplung [material adapter]	PEI - Polyetherimid		
Material Ferrule [material ferrule]	Keramik [ceramic]		
Farbe LCdx Kupplung [colour LCdx adapter]	Aqua – ähnlich RAL 6027 [aqua – similar RAL 6027]		
Steckzyklen [mating cycles]	> 750		
Rückseite: Eigenschaften Kupplung [rear side: characteristics adapter]			
Kupplungstyp Rückseite [type of adapter rear side]	MTP®	MPO	
Hersteller / Produktreihe [manufacturer / brand]	US Conec	z.B. Senko, Nissin, und andere [e.g. Senko, Nissin, and others]	
Material Kupplung [material adapter]	PEI - Polyetherimide	PEI - Polyetherimide	
Farbe [colour]	Schwarz– ähnlich RAL9005 [black – similar to RAL 9005]	Schwarz– ähnlich RAL9005 [black – similar to RAL 9005]	
Kupplungsorientierung [orientation of adapter]	gekreuzt [crossed]	gekreuzt [crossed]	
	 <p>*exemplarische Abbildung [exemplary picture]</p>		
LCdx	MPO/MTP®		
 <p>*exemplarische Abbildung [exemplary picture]</p>	 <p>*exemplarische Abbildung [exemplary picture]</p>		

Zeichnung
[drawing]

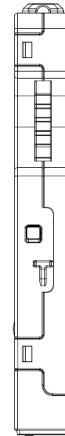
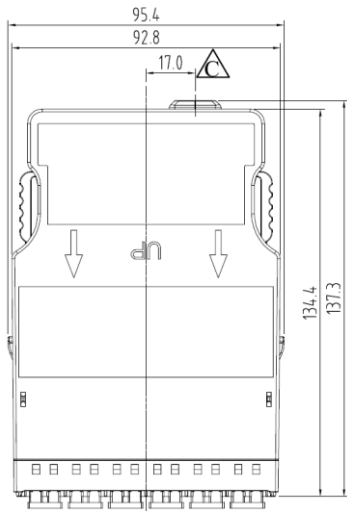

1 Kassettenunterteil
[bottom part of cassette]

2 LWL Kupplung
[FO adapter]

3 Entriegelungslasche linksseitig
[release latch left sided]

4 Entriegelungslasche rechtsseitig
[release latch right sided]

5 Auslass für MPO/MTP® oder Gummitülle
[outlet for MPO/MTP® or rubber grommet]

6 Verschraubung
[screw connection]

7 Faserspule
[fibre spool]

8 Kassettenoberteil
[top part of cassette]

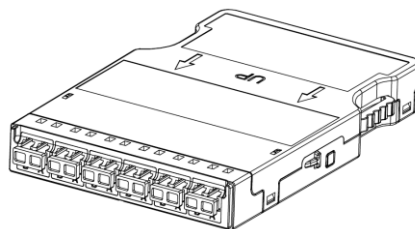
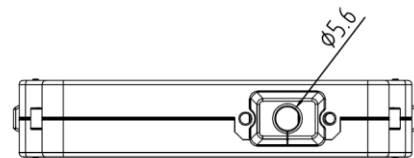
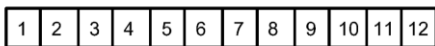
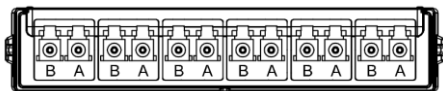
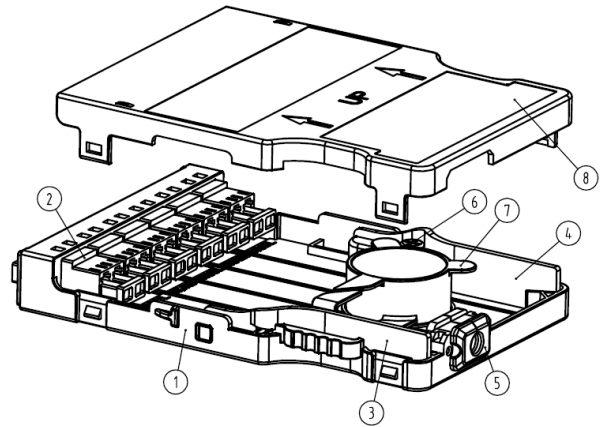

Eigenschaften MPO/MTP® Breakoutkabel [characteristics MPO/MTP® breakoutcable]

Spezifikation: Faser [specification: fibre]

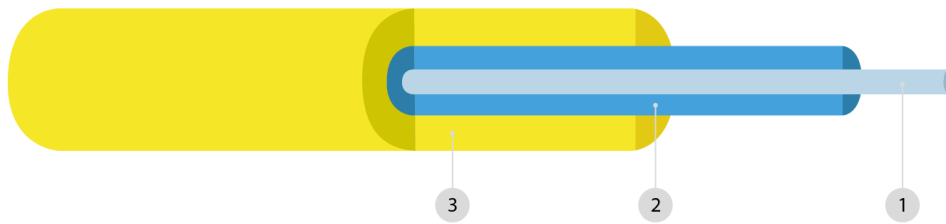

*exemplarische Abbildung, Produkt kann farblich abweichen
[exemplary picture, product may vary in colour]

1	Kern [core]	2	Ummantelung [cladding]	3	Beschichtung [coating]
Fasertyp [type of fibre]		Multimode Faser, G50/125, OM3 [multimode fibre, G50/125, OM3]			
Außendurchmesser [mm] [outer diameter [mm]]		0,9			
Faserspezifikation [fibre specification]		IEC 60793-2-10			
Materialkonformität [material compliant to]		RoHS, REACH, non-halogen			
Dämpfung [attenuation]		3,0 dB/km			

Spezifikation: Stecker [specification: connector]

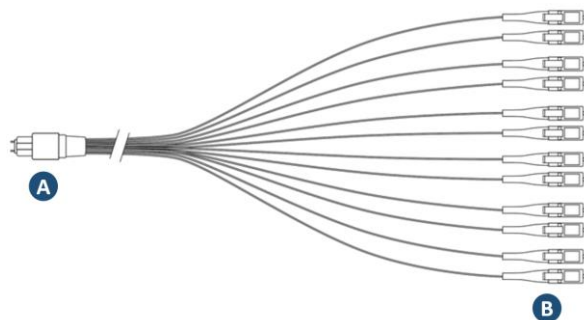

*exemplarische Abbildung
[exemplary picture]

Steckertyp – Seite A [connector types - side A]	MPO/MTP®			
Hersteller / Produktreihe [manufacturer / brand]				
	MTP®	US Conec		
	MPO	z.B. Senko, Nissin, und andere [e.g. Senko, Nissin, and others]		
Gender [gender]	male (pinned) female (unpinned)			
Dämpfung [attenuation]				
	MTP®		MPO	
	Singlemode	Multimode	Singlemode	Multimode
Insertion Loss [IL]	≤ 0,70 dB	≤ 0,35 dB	≤ 0,7 dB	≤ 0,6 dB
Return Loss [RL]	≥ 25 dB (APC >50 dB)		≥ 25 dB (APC ≥ 50 dB)	

Norm Steckverbinder <i>[norm of connector]</i>		
gemäß <i>[compliant to]</i>	IEC 61754 – Fibre optic connector interfaces	
Polarität <i>[polarity]</i>	A, B, C	
weitere Normen <i>[other standards]</i>	TIA-604-5 – Fibre Optic Connector Intermateability Standard TIA/ EIA-568-C.3 – Optical Fibre Cabling Components	
Steckertyp – Seite B <i>[connector types – side B]</i>	LC	
Dämpfung <i>[attenuation]</i>		
	Singlemode	Multimode
Insertion Loss [IL]	≤0,2 dB	≤0,2 dB
Return Loss [RL]	≥ 45 dB (APC >60 dB)	≥20 dB
Norm Steckverbinder <i>[norm of connector]</i>		
	Singlemode	IEC 61753-2 – „Grade C“
	Multimode	IEC 61753-122-2 – „Grade C“

Lieferform Allgemein
[delivery type general]

Lieferform [type of delivery]	Pappkarton [carton box]
Gewicht [kg] [weight [kg]]	0,12

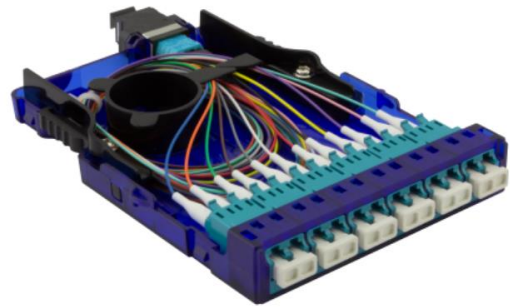
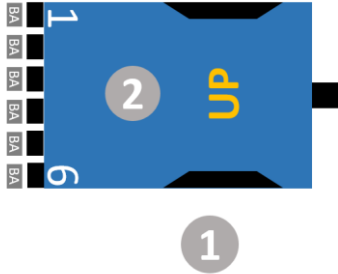

*exemplarische Abbildung
[exemplary picture]

1 Entriegelungslasche
[release lug]

2 Kassettengehäuse
[cassette housing]

Farbcode nach
[colour code acc. to]



TIA-598-C

Kupplung Typ A - gekreuzt

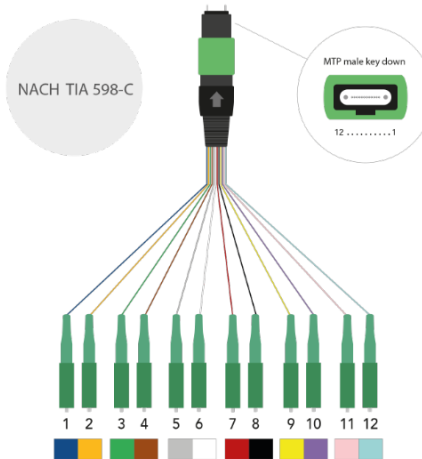
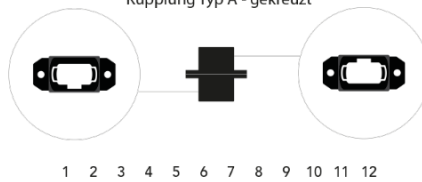

*exemplarische Abbildung
[exemplary picture]

Verbindungsübersicht und Produktratgeber für MPO/MTP® Kassettentechnik [connectivity overview and product guide for MPO/MTP® cassette technology]

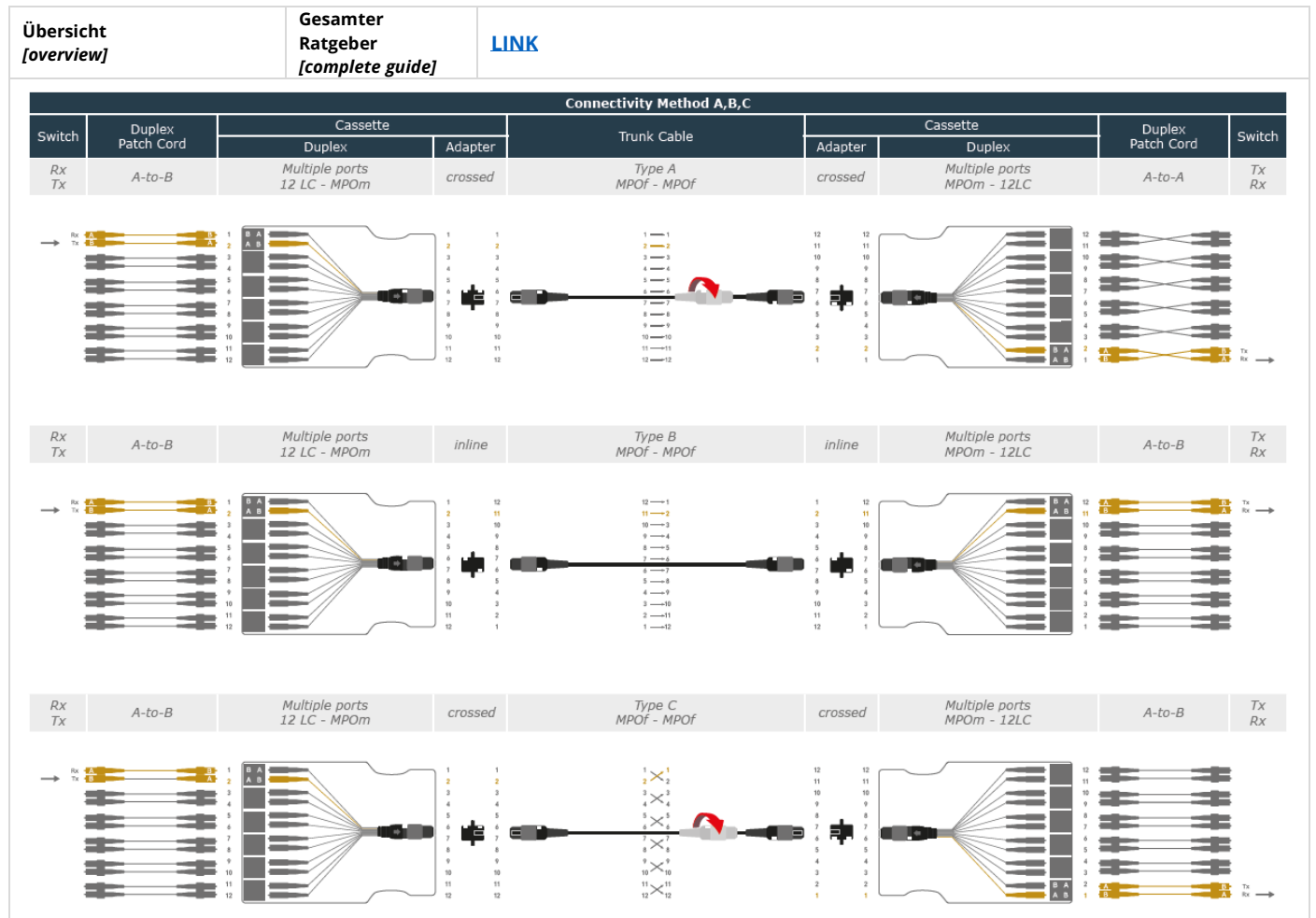

Bestellangaben [ordering information]

Artikelnummer [part no.]	Beschreibung [description]															
Kassettenversion: MPO(x) [version of the cassette: MPO(x)]																
4677414-OF-PC-A	CAS-MPO - RZ-Modulkassette 6x LCdx-PC OM3 - aqua - 1x MPOf - PC (A) - inkl. 12-Faser Breakoutkabel [CAS-MPO - DC modular cassette 6x LCdx-PC OM3 - aqua- 1x MPOf - PC (A) - incl. 12-fibre breakout cable]															
4677414-OM-PC-A	CAS-MPO - RZ-Modulkassette 6x LCdx-PC OM3 - aqua - 1x MPOm - PC (A) - inkl. 12-Faser Breakoutkabel [CAS-MPO - DC modular cassette 6x LCdx-PC OM3 - aqua- 1x MPOm - PC (A) - incl. 12-fibre breakout cable]															
Kassettenversion: MTP®(x) [version of the cassette: MTP®(x)]																
4677414-PF-PC-A	CAS-MPO - RZ-Modulkassette 6x LCdx-PC OM3 - aqua - 1x MTP®f - PC (A) - inkl. 12-Faser Breakoutkabel [CAS-MPO - DC modular cassette 6x LCdx-PC OM3 - aqua- 1x MTP®f - PC (A) - incl. 12-fibre breakout cable]															
4677414-PM-PC-A	CAS-MPO - RZ-Modulkassette 6x LCdx-PC OM3 - aqua - 1x MTP®m - PC (A) - inkl. 12-Faser Breakoutkabel [CAS-MPO - DC modular cassette 6x LCdx-PC OM3 - aqua- 1x MTP®m - PC (A) - incl. 12-fibre breakout cable]															
	<p>Legende: [legend:]</p> <table border="0"> <tr> <td>Steckertyp: [type of connector:]</td> <td>Politur an der MPO/MTP® Seite: [polish on MPO/MTP® side:]</td> <td>Polarität: [polarity:]</td> </tr> <tr> <td>OF - MPO female</td> <td>PC - PC</td> <td>A</td> </tr> <tr> <td>OM - MPO male</td> <td>A8 - APC8</td> <td>B</td> </tr> <tr> <td>PF - MTP® female</td> <td></td> <td>C</td> </tr> <tr> <td>PM - MTP® male</td> <td></td> <td></td> </tr> </table>	Steckertyp: [type of connector:]	Politur an der MPO/MTP® Seite: [polish on MPO/MTP® side:]	Polarität: [polarity:]	OF - MPO female	PC - PC	A	OM - MPO male	A8 - APC8	B	PF - MTP® female		C	PM - MTP® male		
Steckertyp: [type of connector:]	Politur an der MPO/MTP® Seite: [polish on MPO/MTP® side:]	Polarität: [polarity:]														
OF - MPO female	PC - PC	A														
OM - MPO male	A8 - APC8	B														
PF - MTP® female		C														
PM - MTP® male																

Bestellangaben - Zubehör [ordering information - accessories]

Artikelnummer [part no.]	Beschreibung [description]
4677270	Verteilerfeldrahmen (leer) zur Aufnahme von 8x Modulkassetten inkl. Kabelmanagementbügel [Patch panel chassis (empty) for mounting of 8x modular cassettes incl. cable management]
4677279	Luftabschlussblende zur Vermeidung unkontrollierter Luftzirkulation für modulares Verteilerfeld [Blanking plate for stopping uncontrolled air circulation for modular patch panel]